

ACCUFORM SYSTEM

DETAIL LAYOUT

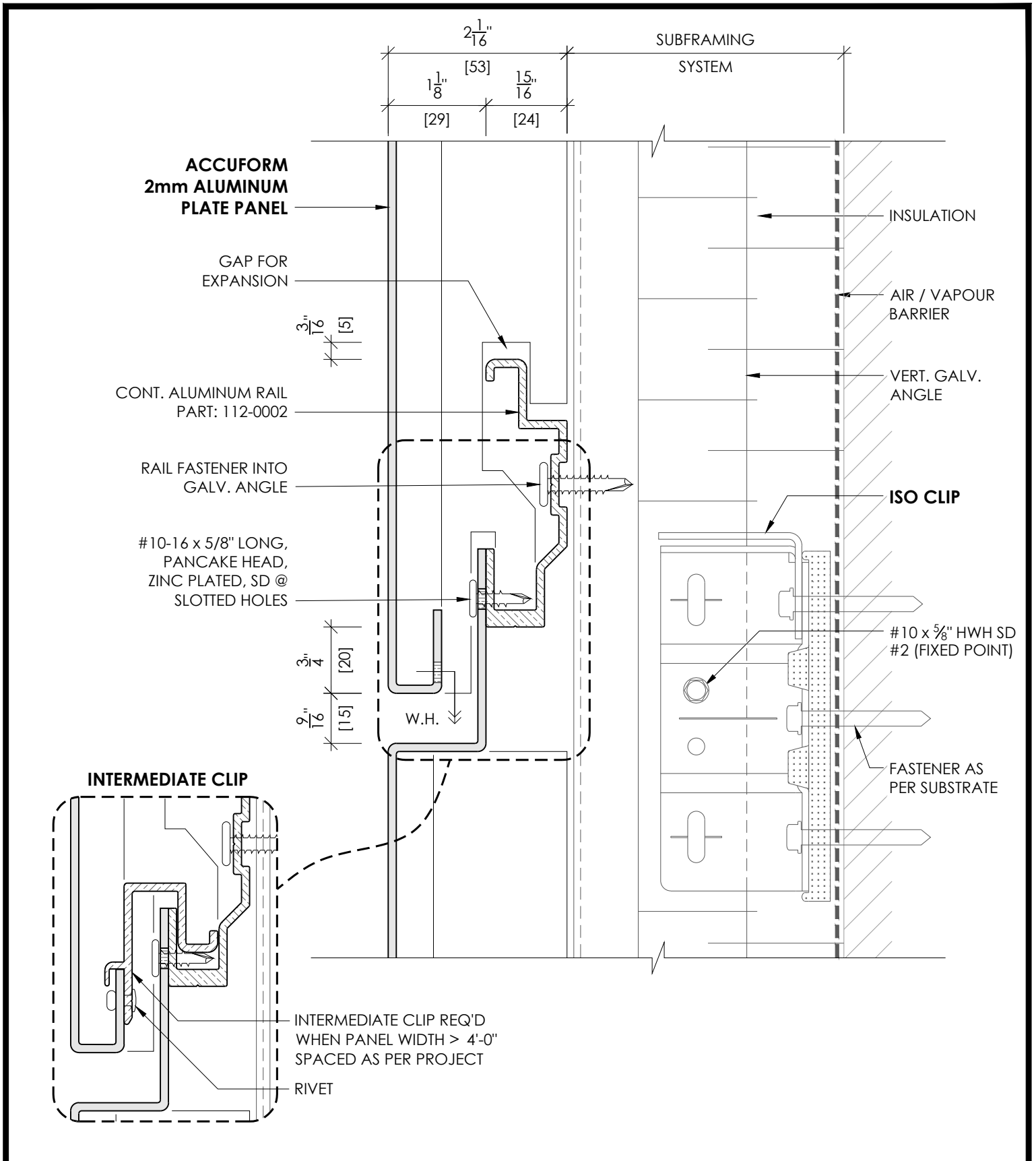

ACCUFORM SYSTEM

HORIZONTAL JOINT

DETAIL 1

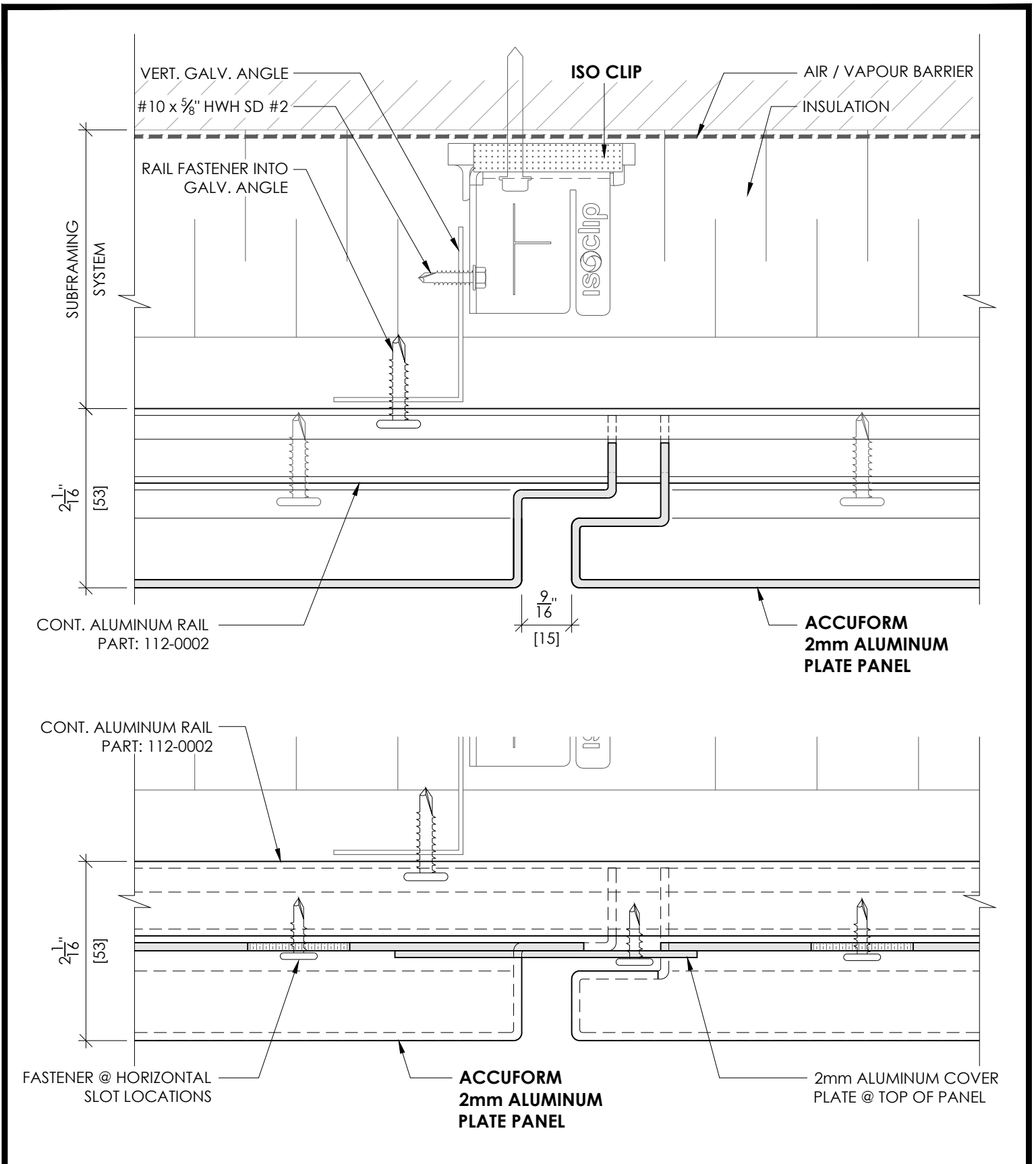

ACCUFORM SYSTEM

VERTICAL JOINT

DETAIL 2



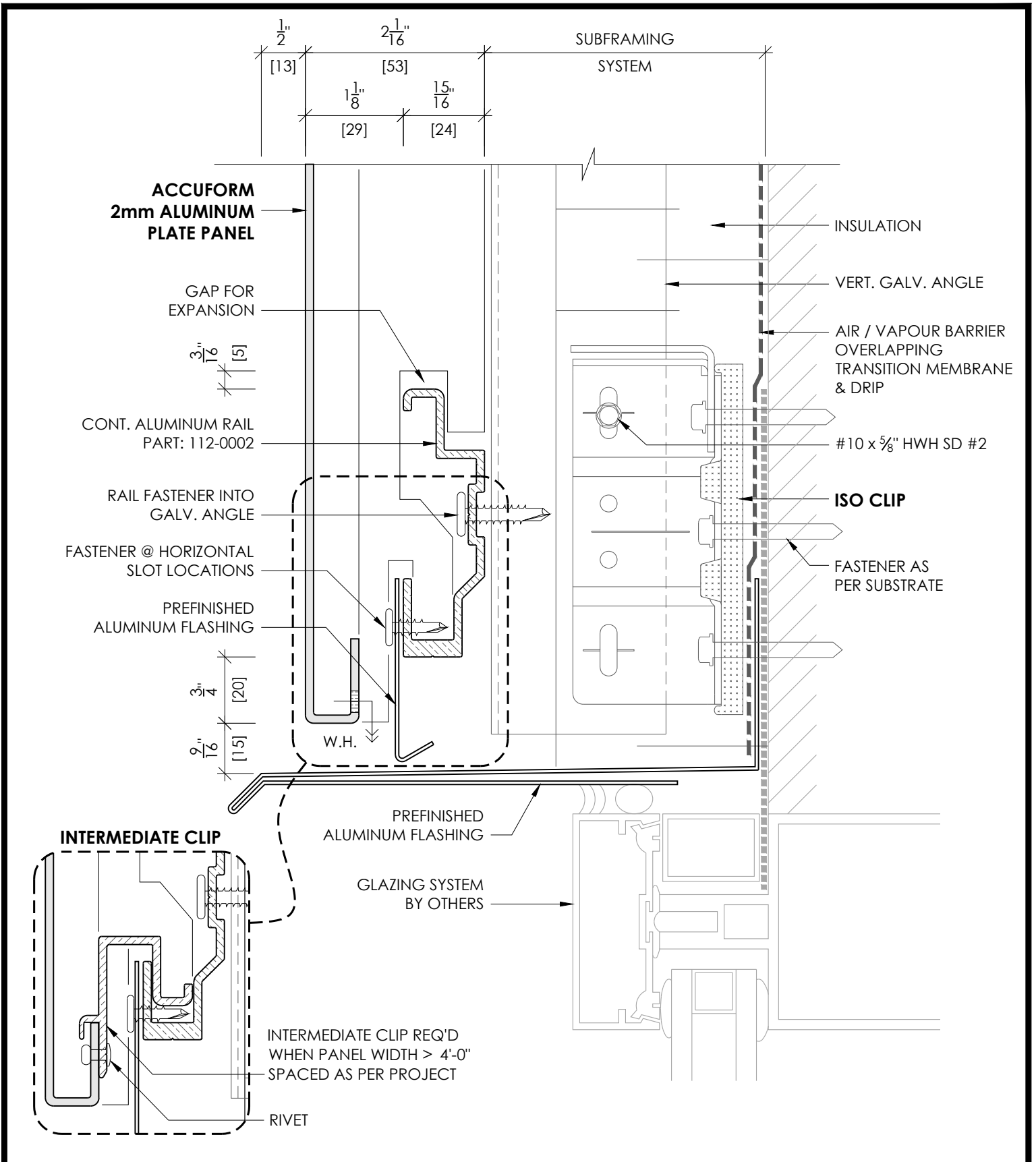

ACCUFORM SYSTEM

WINDOW HEAD

DETAIL 3

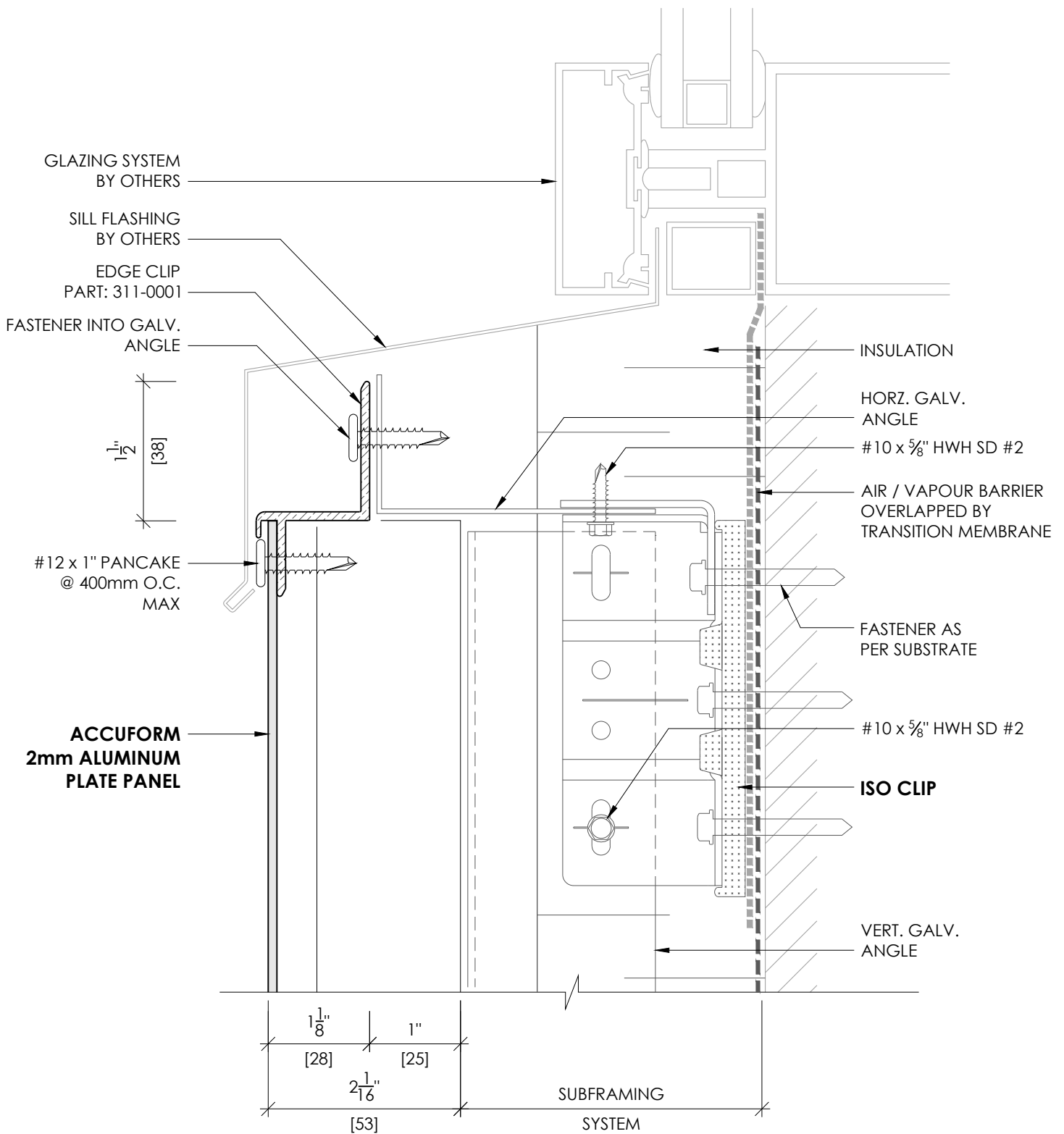

ACCUFORM SYSTEM

WINDOW SILL

DETAIL 4

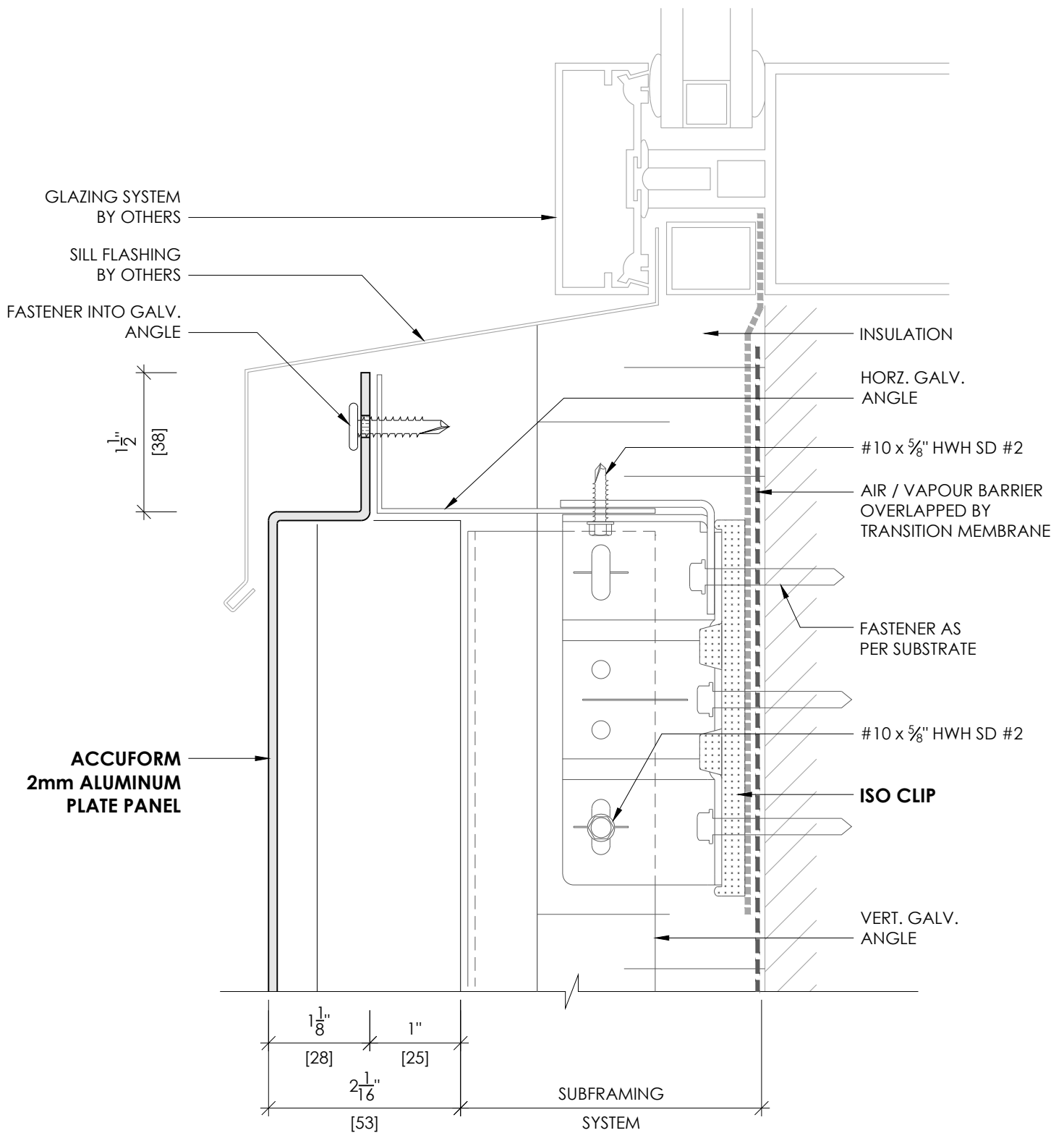

ACCUFORM SYSTEM PREMIUM

WINDOW SILL

DETAIL 4A

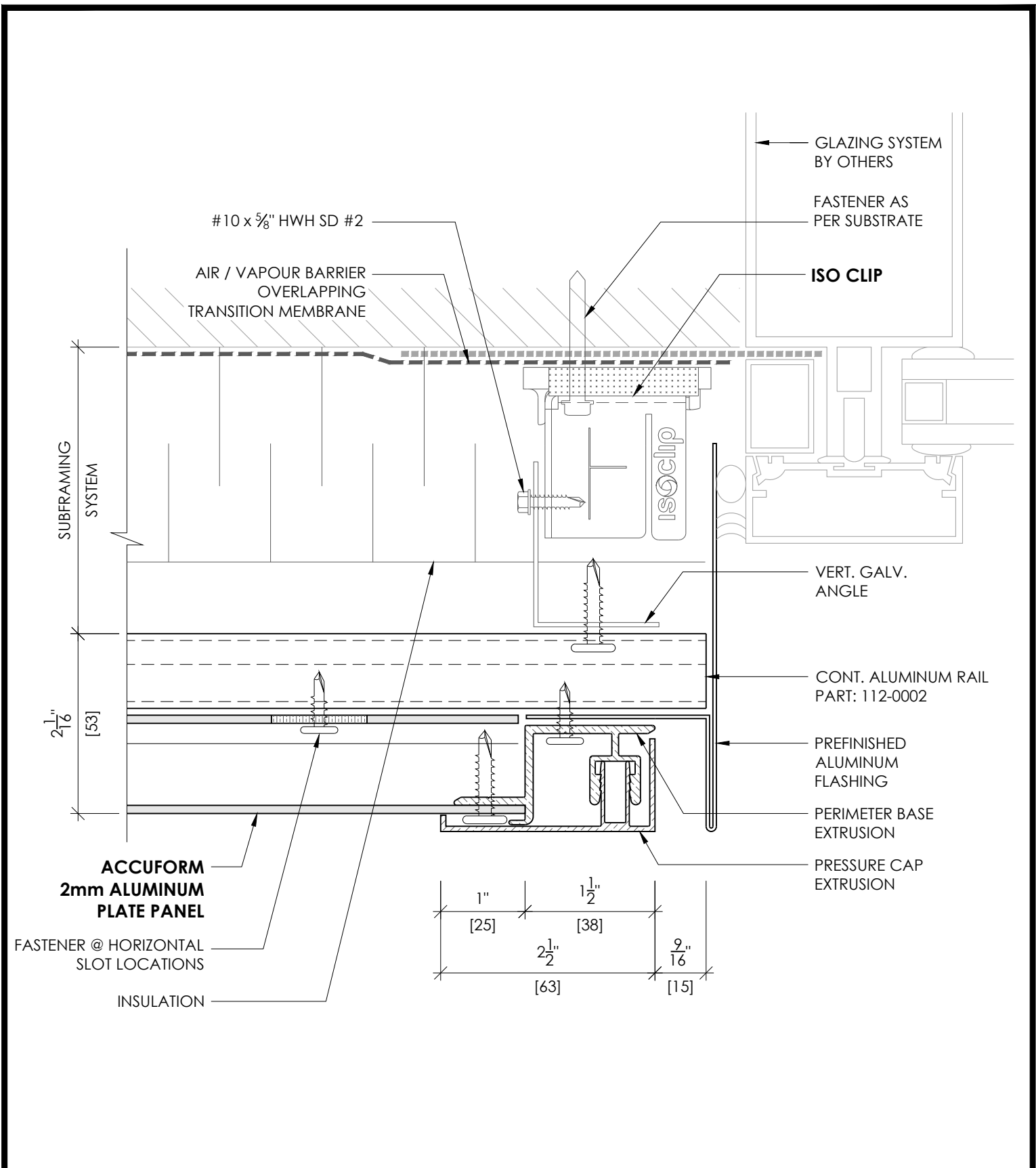

ACCUFORM SYSTEM

WINDOW JAMB

DETAIL 5

This drawing is the sole property of and may only be reproduced upon receipt of written permission from FLYNN CANADA LTD. / NOV 2024

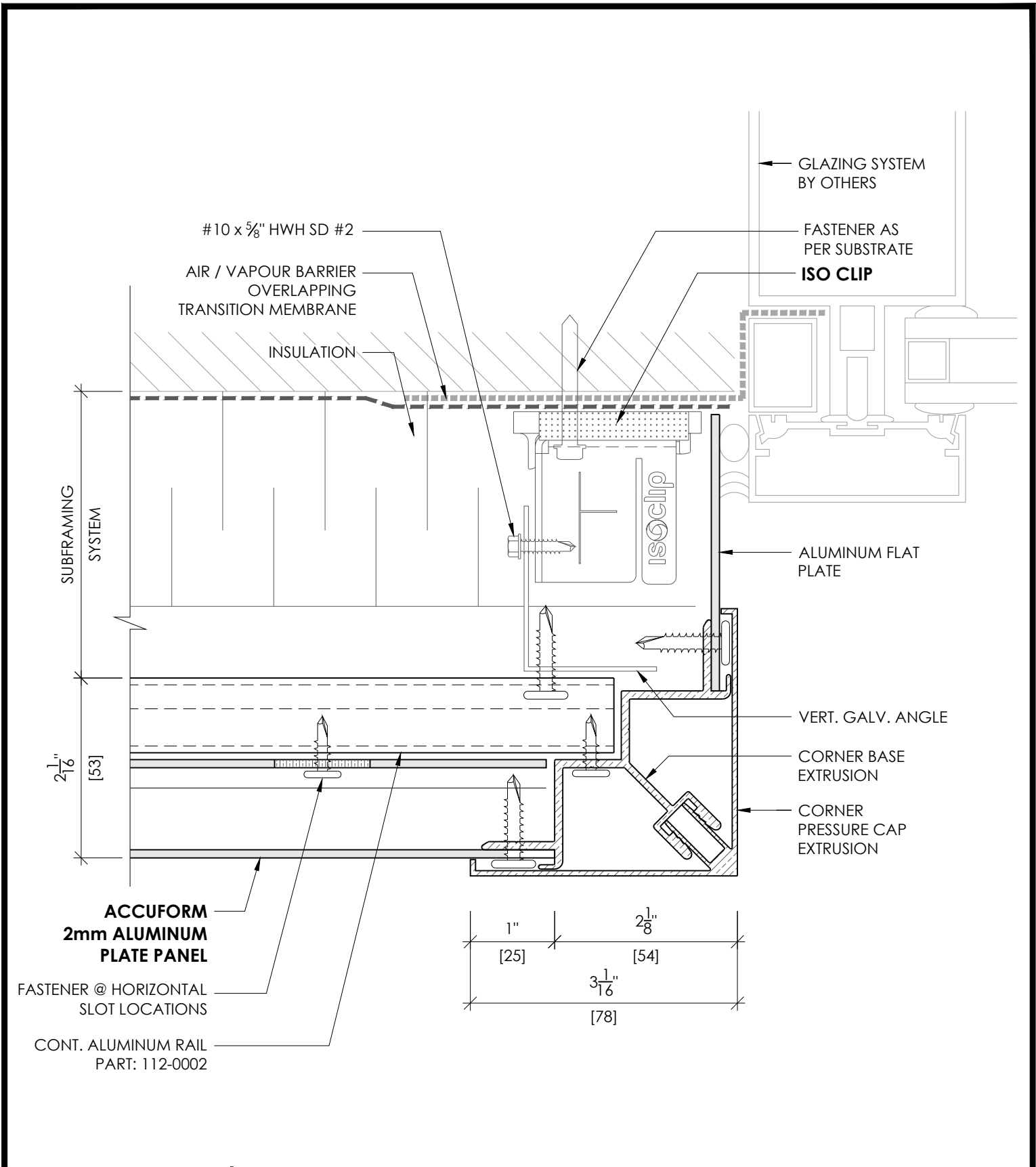

ACCUFORM SYSTEM

WINDOW JAMB

DETAIL 5A

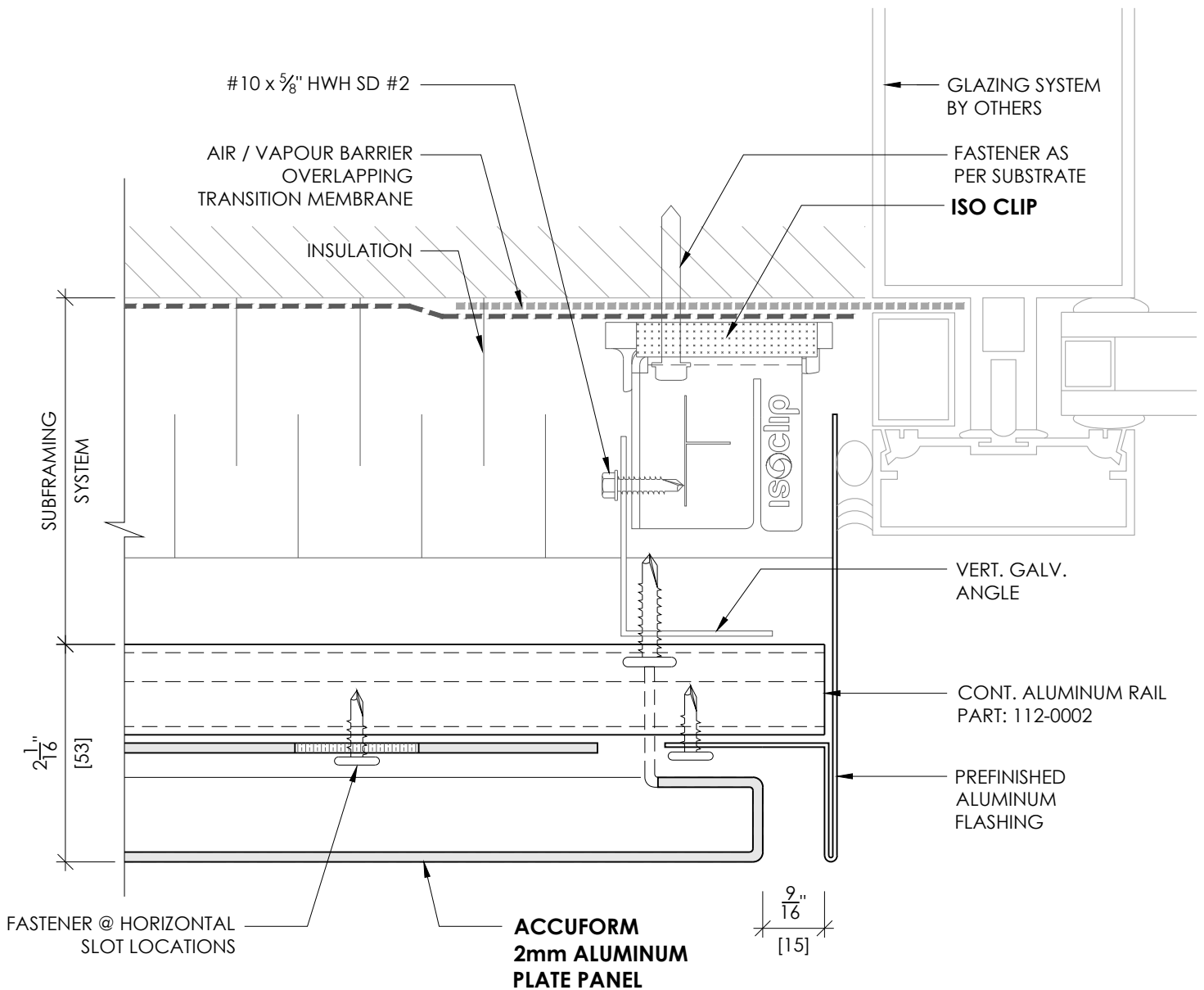

ACCUFORM SYSTEM - PREMIUM

WINDOW JAMB

DETAIL 5B

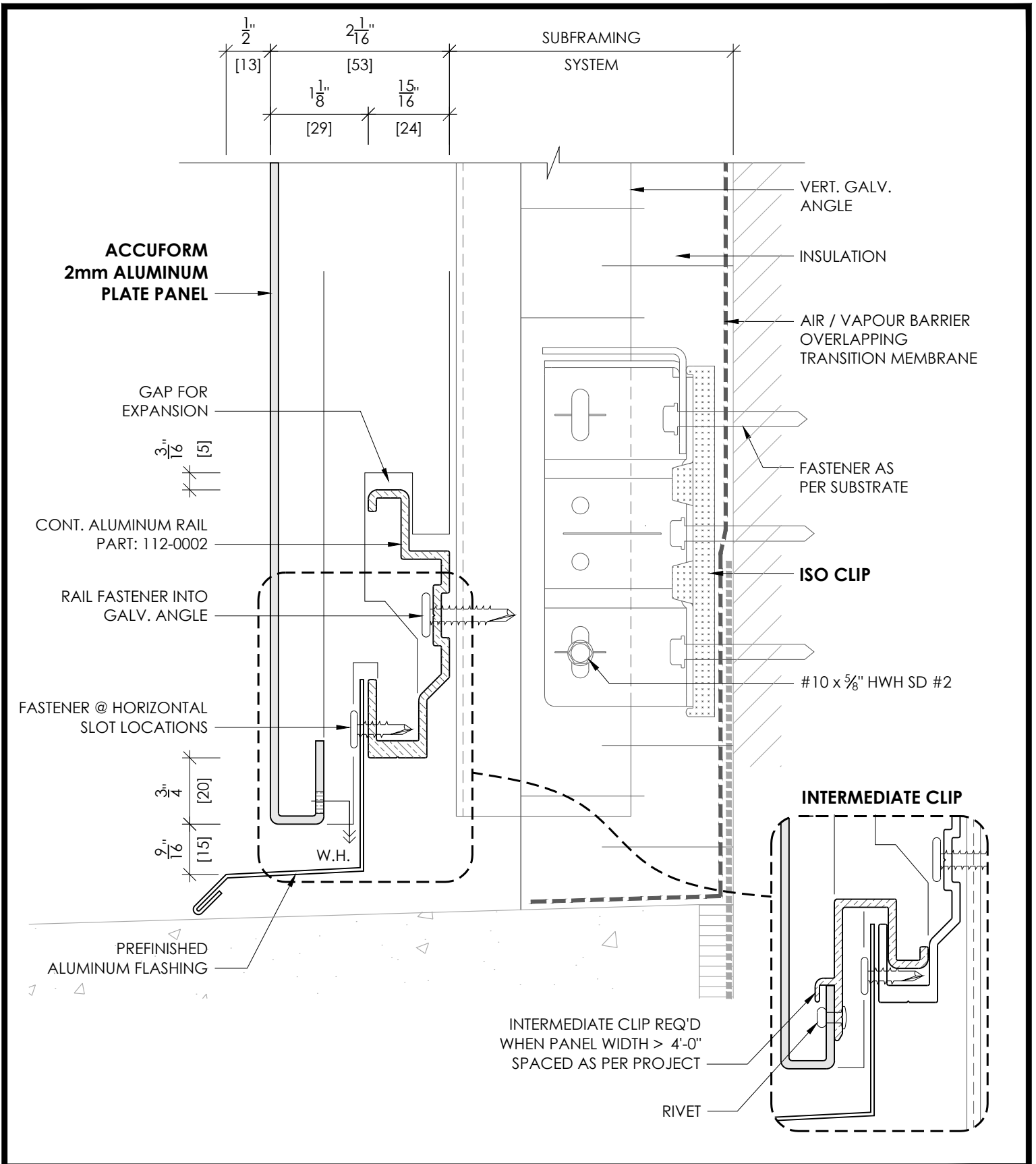

ACCUFORM SYSTEM

BASE DETAIL

DETAIL 6

This drawing is the sole property of and may only be reproduced upon receipt of written permission from FLYNN CANADA LTD. / NOV 2024

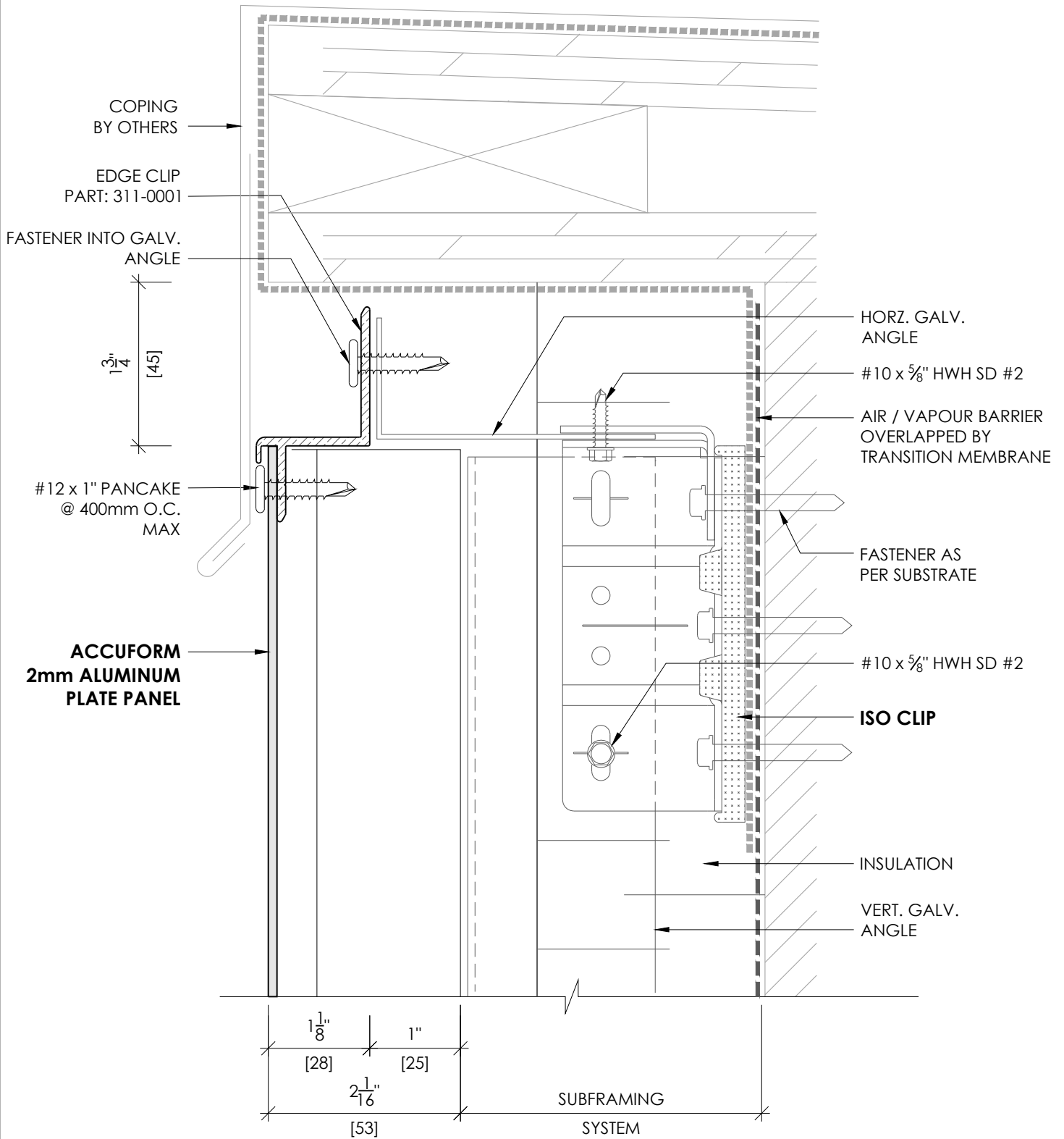

ACCUFORM SYSTEM

PARAPET DETAIL

DETAIL 7

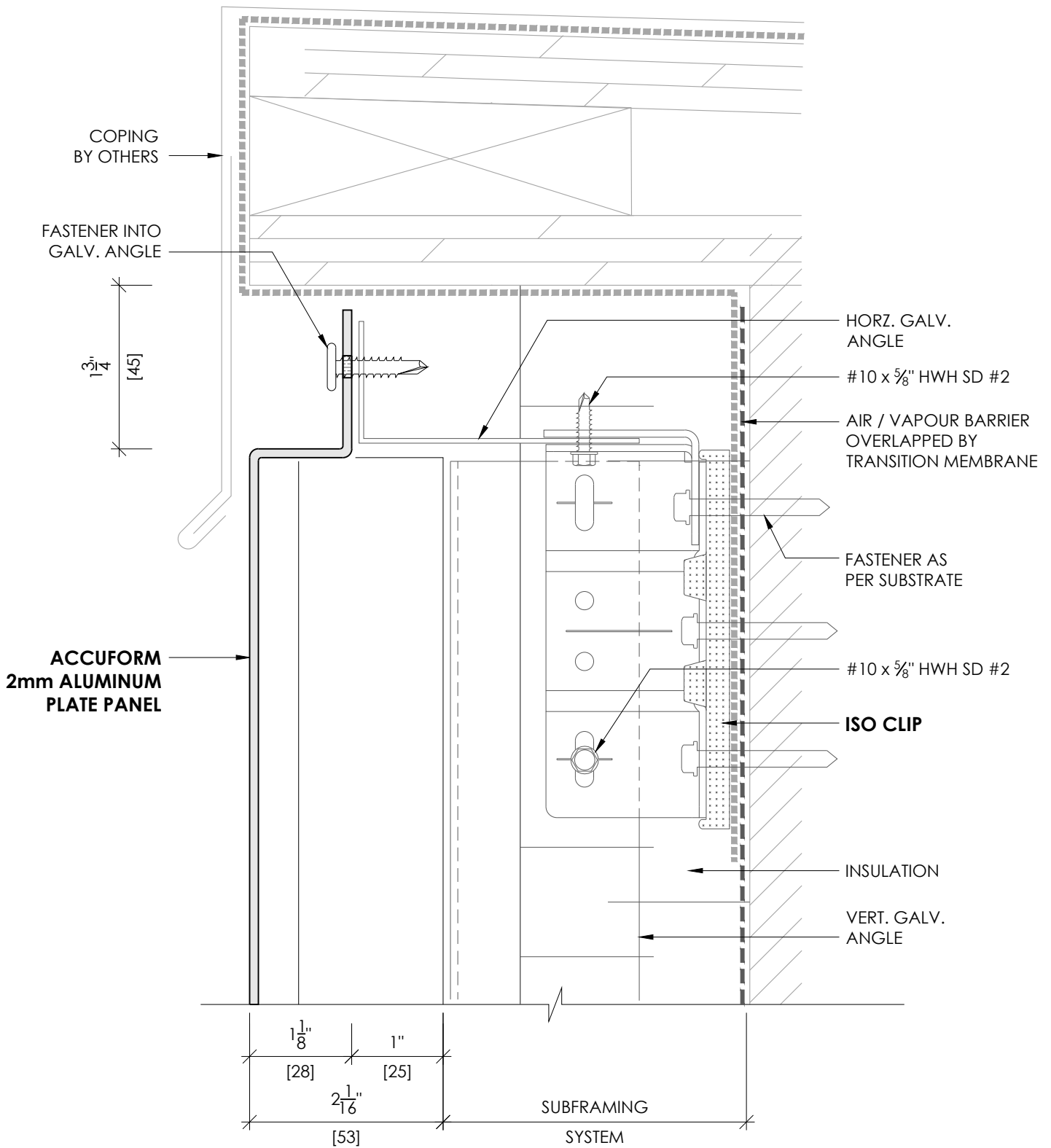

ACCUFORM SYSTEM PREMIUM

PARAPET DETAIL

DETAIL 7A

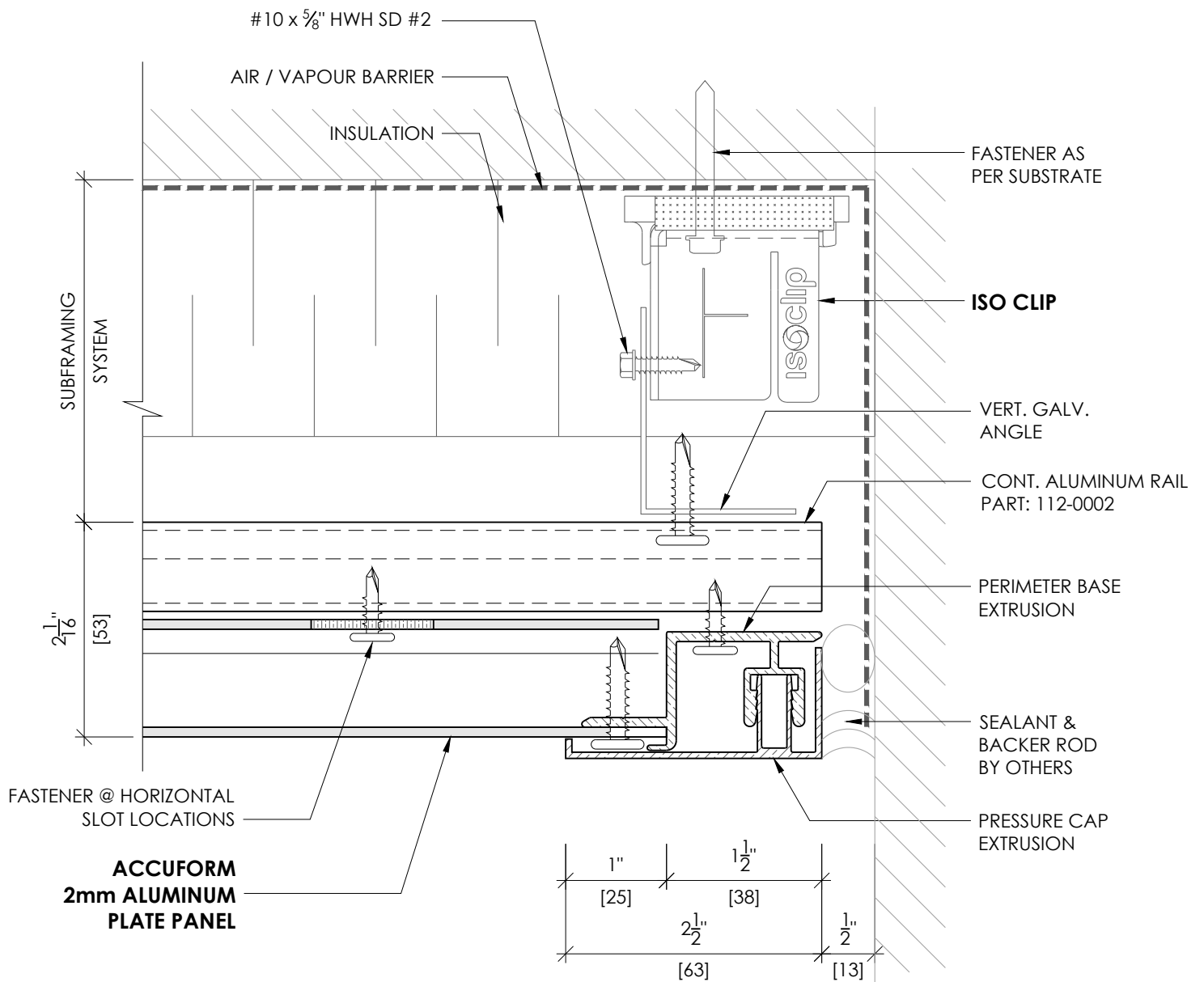

ACCUFORM SYSTEM

END DETAIL

DETAIL 8



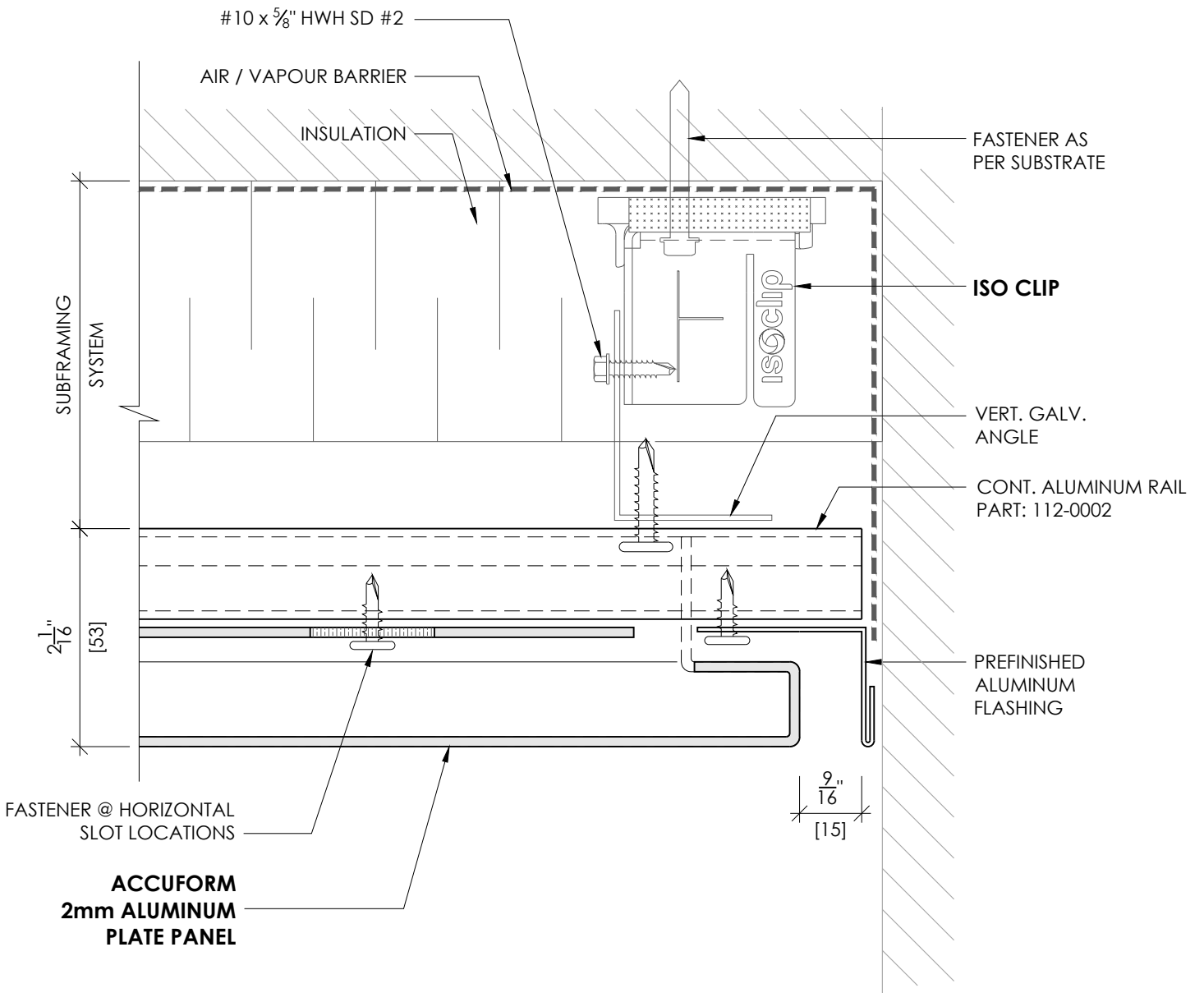

ACCUFORM SYSTEM - PREMIUM

END DETAIL

DETAIL 8A

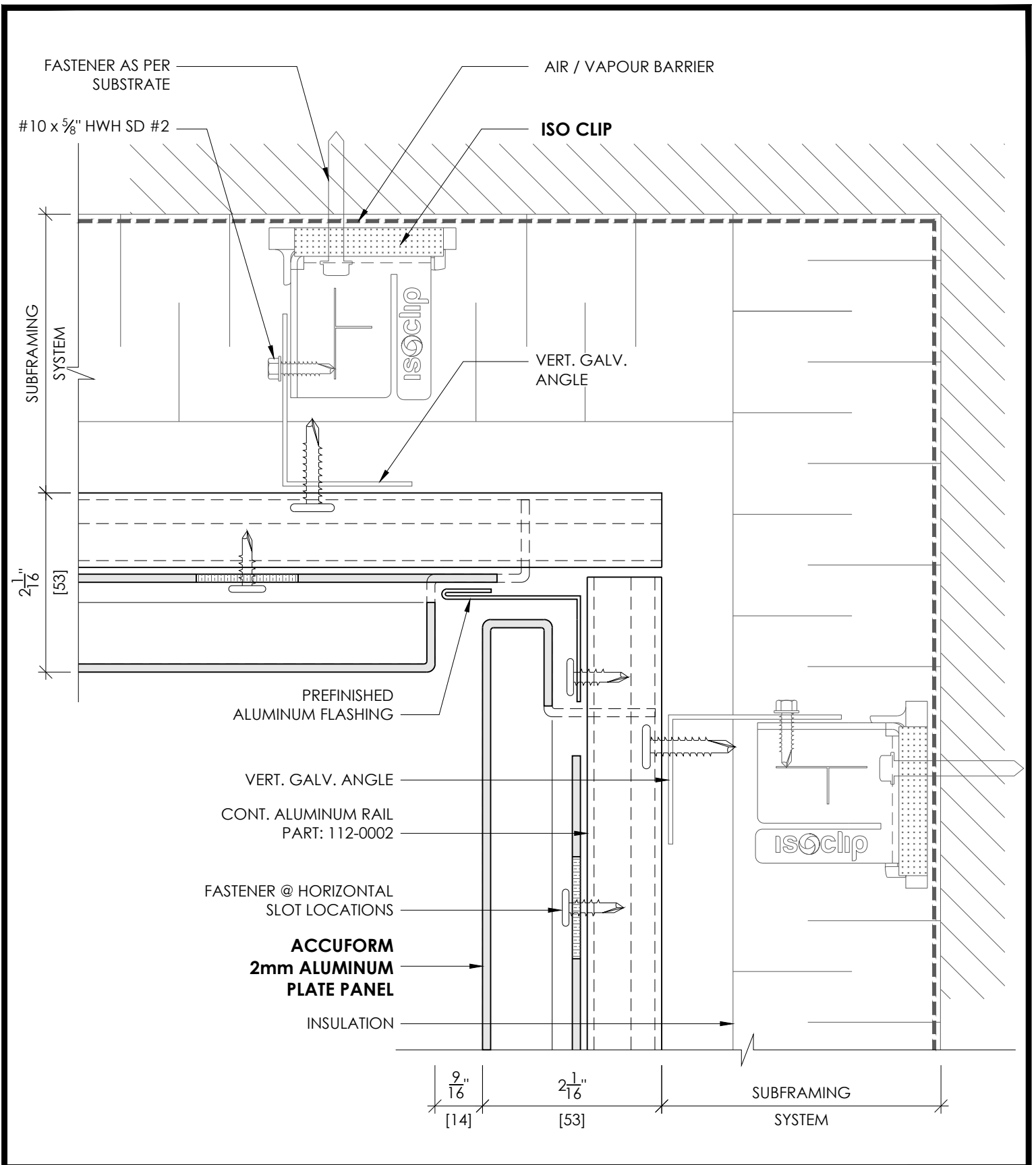

ACCUFORM SYSTEM

INSIDE CORNER DETAIL

DETAIL 9

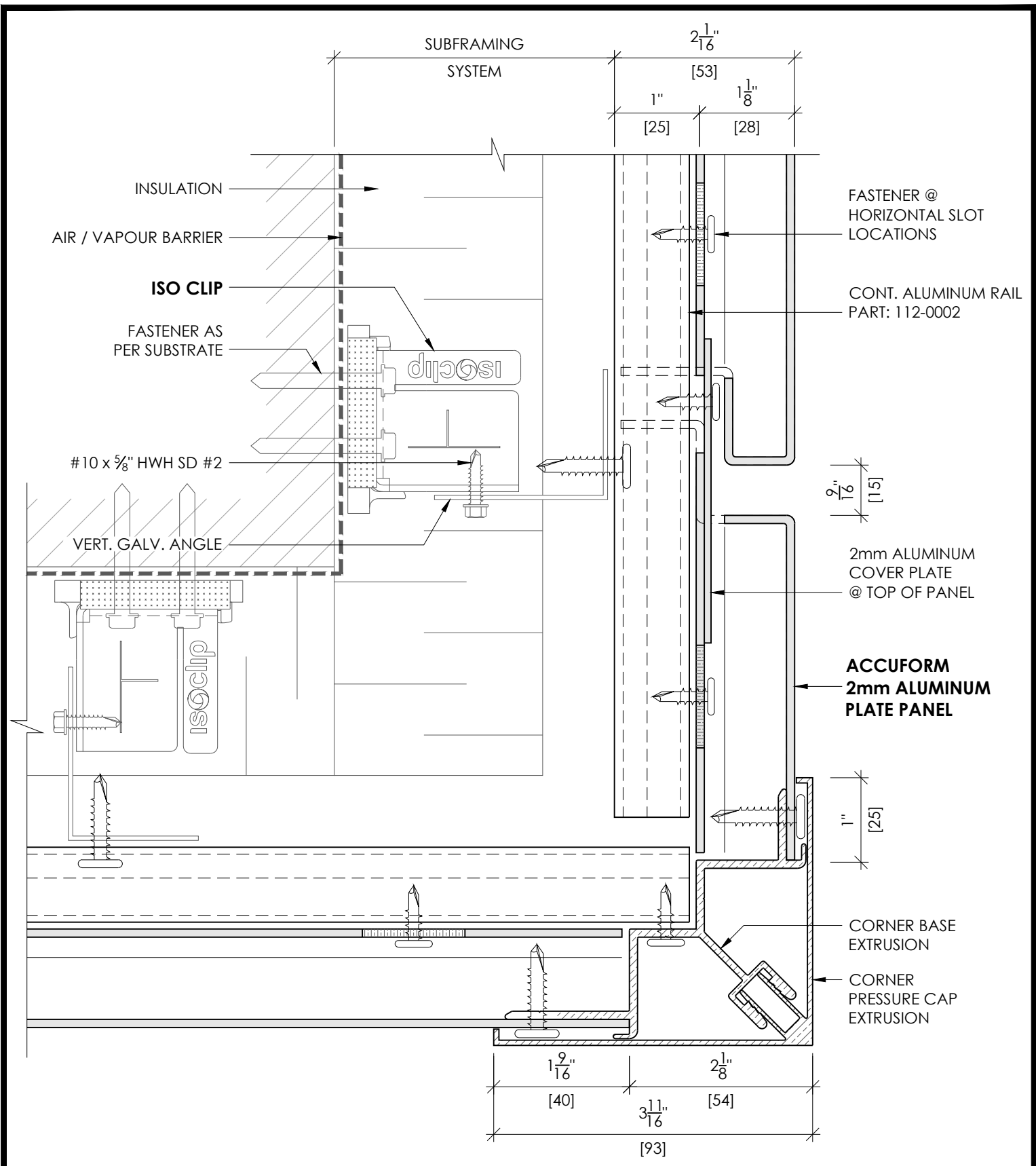

ACCUFORM SYSTEM

OUTSIDE CORNER DETAIL

DETAIL 10

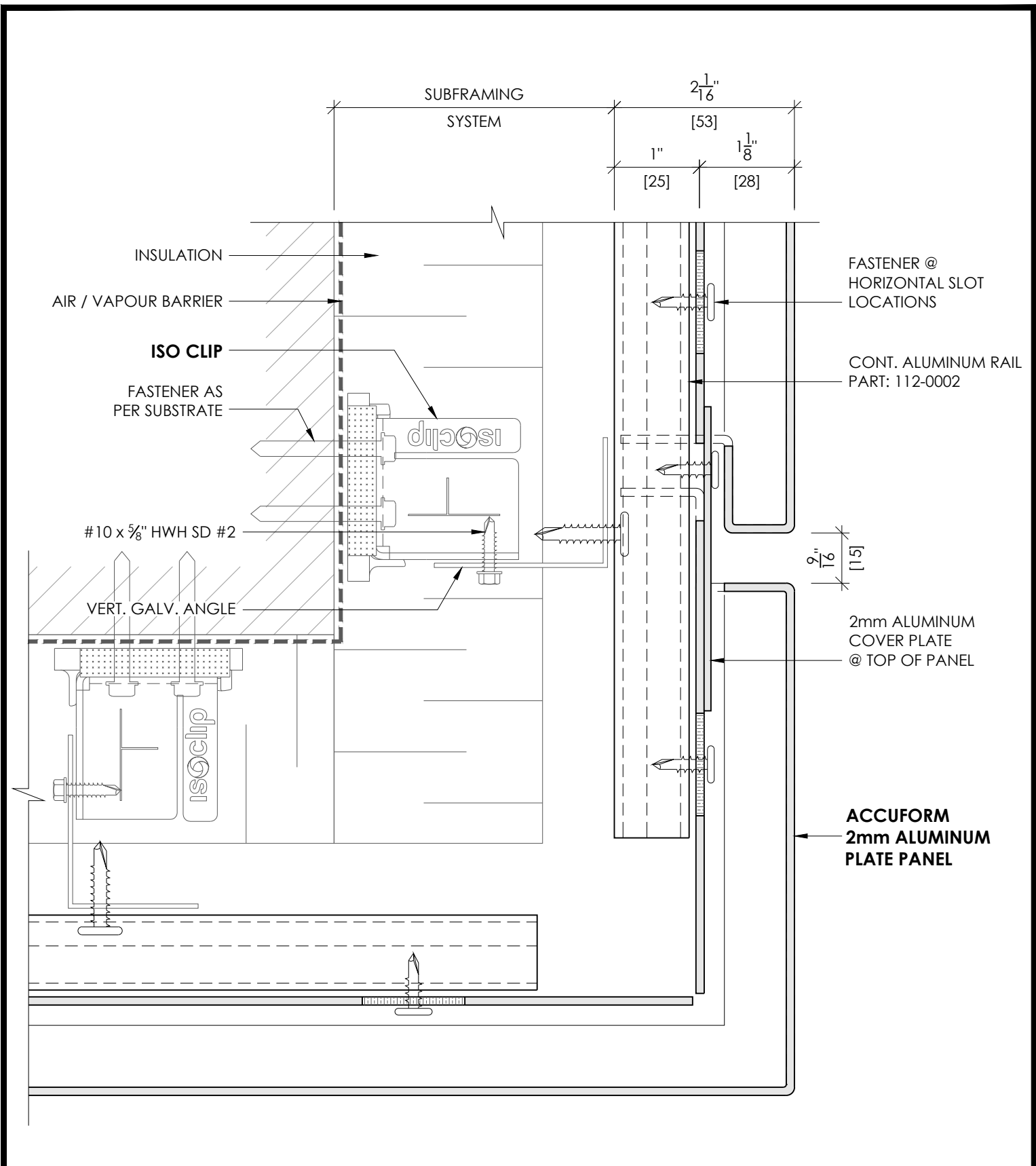

ACCUFORM SYSTEM PREMIUM

OUTSIDE CORNER DETAIL

DETAIL 10A